

QUAD AMPLIFIER

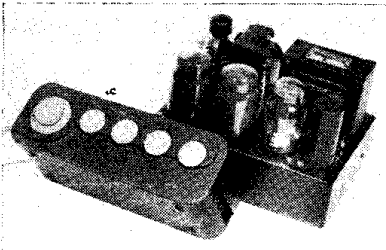

High fidelity 12-watt push-pull amplifier with separate quality control unit. Input sockets provided for radio, microphone and pickup signals and output terminals for 7.5 and 15 ohm PM speakers. Main amplifier is supplied in chassis form with base cover. Control unit has an enclosing metal casing with die-cast aluminium front panel. Suitable for 200 to 250V, 40-80c/s. Made by The Acoustical Manufacturing Co., Ltd., Huntingdon, Hunts.

THE "Quad" amplifier consists of a high grade low distortion amplifier together with a separate quality control unit. The control unit provides two stages of amplification with negative feedback which varies with the volume control setting from 6dB at maximum volume to 35dB near zero. The unit also incorporates continuously variable bass and treble controls giving both lift and cut, and a specially designed low-pass filter circuit, the slope of which can be varied to attenuate at the rate of from 10 to 100 dB per octave commencing at either 6 or 8kc/s. Filters and bass and

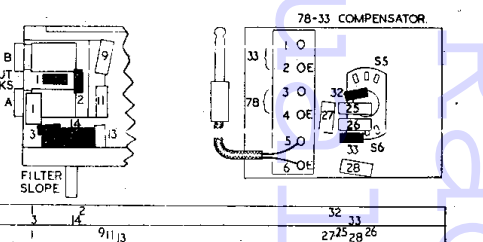
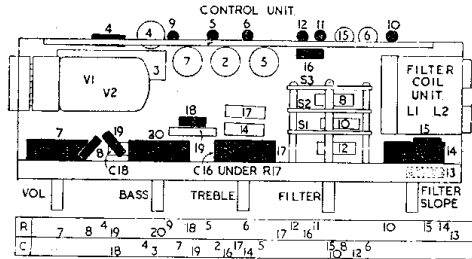
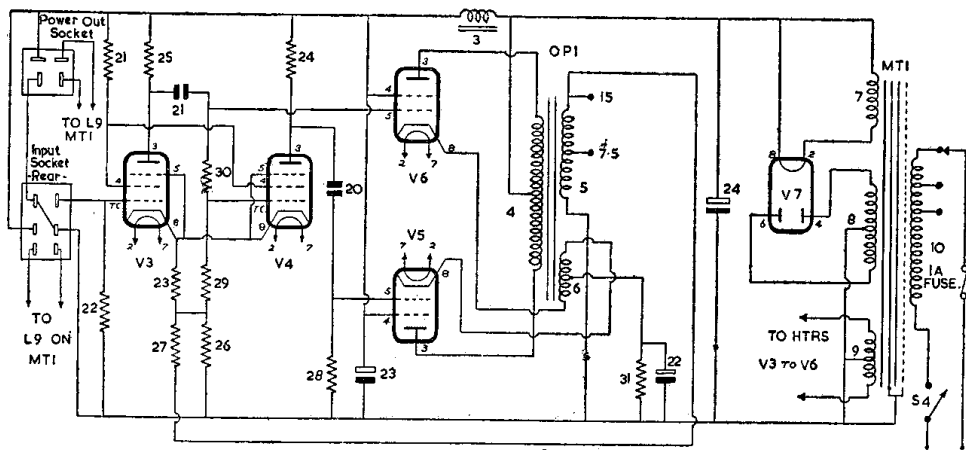
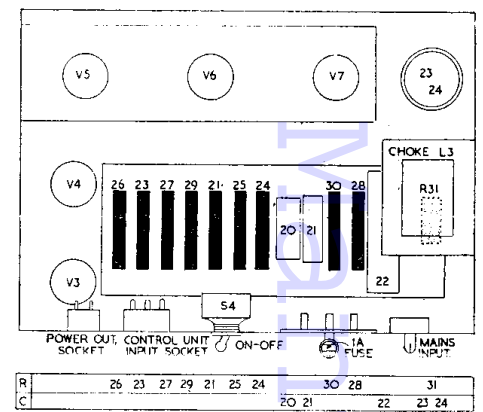
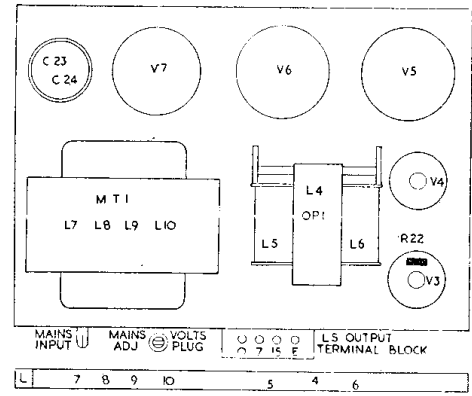

V1-V2-ECC35	V3-EF37	V4-EF37	V5-KT66	V6-KT66	V7-SU4G

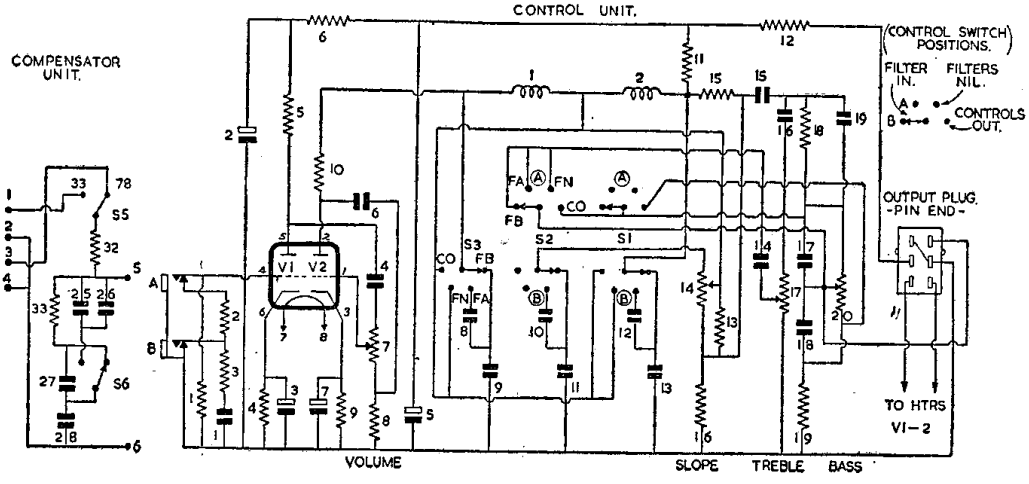

RESISTORS

R	Ohms	Watts
1	1.5M	...
2	47K	...
3	10K	...
4	1.5K	...
5	100K	...
6	100K	...
7	750K	Linear Potr.
8	470K	...
9	1.5K	...
10	10K	...
11	100K	...
12	47K	...
13	270K	...
14	500K	Log Law Potr.
15	47K	...
16	2.2M	...
17	500K	Semi-Log Potr.
18	100K	...
19	27K	...
20	500K	Semi-Log Potr.
21	330K	...1W
22	1.5M	...
23	1.5K	...
24	180K	...
25	180K	...
26	100	...

CAPACITORS

C	Capacity	Type
1	.05 Tubular	250V
2	.8 Electrolytic	450V
3	.50	12V
4	.25 Tubular	350V
5	.8 Electrolytic	450V
6	.1 Tubular	350V
7	50 Electrolytic	12V
8	.001 Mica	...
9	.001	...
10	.002	...
11	.002	...
12	.001	...
13	.001	...
14	.004	...
15	.1Tubular	350V

INDUCTORS

L	Ohms
1	1700
2	1700
3	3000
4	150 Total(90+60)
5	.75 (.5+25)
6	.16 (8+8)
7	very low
8	140 (70+70)
9	very low
10	21 Total (1+1+19)

QUAD AMPLIFIER—Continued

treble controls can be switched out of circuit in one position of control switch to give flat response for comparison purposes.

Control unit is provided with two input jacks A and B, the latter incorporating fixed bass compensating circuit for uncorrected pickups. Control unit is coupled to main amplifier by a flexible cable approximately 4ft. in length.

Main amplifier consists of two EF37's driving two KT66 beam-tetrode push-pull output valves.

The output transformer is of special design with 13 sectional windings tightly coupled and interconnected to form centre-tapped primary, centre-tapped cathode-driven secondary, and tapped output secondary for 7.5 and 15 ohm speakers. This arrangement distributes loading between cathodes, anodes and screen circuits and is said to be such that the output valves function as triodes but with less than half the non-linearity of a conventional push-pull triode circuit.

Negative feedback amounting to 12 dB is applied from secondary of output transformer to common cathode circuit of push-pull driver valves. Overall frequency response of amplifier with controls switched out is flat within plus or minus 3 dB between 20c/s and 20kc/s. Maximum distortion at 12W output is less than .25 per cent.

A compensator to allow the amplifier to be used for reproduction of both standard 78 and long-playing microgroove records is provided as a separate unit. The unit is connected between pickups and input A of control unit and by rotating switch to appropriate setting the corresponding pickup and its compensating network is switched in.

Control Unit. Input signal from a corrected pickup or radio unit is plugged into socket A and thence applied to grid of V1. Signal from an uncorrected pickup is plugged into socket B where it is fed through R2 to grid of V1. Bass compensation is provided by R3, C1.

Cathode bias of V1 is provided by R4, decoupled by C3. Anode load is R5. Signal at anode V1 is fed by C4 to volume control R7, and thence to grid V2. Cathode bias of V2 is provided by R9 decoupled by C7. Anode load is R11, whilst L1, L2 form part of low pass filter network. Voltage developed across R10 is applied as negative feedback through C6 and volume control R7 to grid V2.

With S1 to S3 set to "Controls OUT - NIL Filters" the filter coils L1, L2 and associated components R13 and part R14 are shorted out by S3, S1B respectively. In addition treble control R17 and bass control R20 are placed inoperative by S2A, S1A. This leaves the circuit with a level response.

Output signal developed across R11 is taken through R15, C15, R18, C19 through inter-connecting lead and plug to input socket on main amplifier.

With S1 to S3 switched to "Controls IN - NIL Filters," the filter circuit remains shorted, but treble control R17 and bass control R20 with its associated components C17, C18 are switched in.

With S1 to S3 in "Controls IN - A Filter" position, the short circuit is removed from filter coils L1, L2 and outer ends of the series coupled coils are connected down to chassis through C8, C9 and C12, C13 respectively, and at the same time slope control R14 is switched in circuit to chassis through C10, C11. In this setting of control switch

the filters are tuned to a minimum frequency of 8kc/s and above this frequency the adjustment of slope control R14 varies the rate of attenuation of harmonic content of signal from 10 dB in its Grad position to 100 dB in its Sharp position.

In the final "Controls IN - B Filter" position of S1 to S3, filter frequency is lowered to 6kc/s by switching coils to C9, C13 and slope control to C11.

Compensator unit. The circuit shown is intended for use with constant velocity pickups. Pickup used for microgroove recordings is connected to input terminals 1 and 2, whilst standard type pickup is connected to terminals 3 and 4. With S5 and S6 in "78" position pickup signal is fed through R32 to output terminal whilst bass correction is given by R33, C28. In the "33" position of switch, pickup signal is still fed through R32 to output terminal but the compensation network is adjusted by inclusion of C25, C26 and C27. Output signal of unit is fed through screened lead and jack-plug and fed into input A of control unit.

Main amplifier. Input signal from control unit is fed to V3 of which R22 is grid resistor. Cathode bias of V3, V4 is provided by common resistor R23. R26 is inserted to introduce negative feedback into cathode circuit. Screen voltages of V3, V4 are obtained from common load resistor R21. Signal at anode V3 which is developed across R25 is fed by C21 to V6, one of the push-pull output valves, and through potential divider R29, R30 to V4.

Values of R29, R30 are adjusted to provide an input signal to V4 which when amplified by V4 develops across anode load R24 a signal equal in amplitude to that developed across V3 anode load R25, but of opposite phase. This signal is then fed by C20 to second push-pull output valve V5.

Screen voltage of V5, V6 is obtained direct from HT line to V3, V4, decoupling being given by C23.

Primary L4 of output matching transformer OP1 is in the anode circuit, the HT for which is obtained direct from reservoir smoothing capacitor C24. Cathode bias is provided by R31 decoupled by C22. Cathodes are connected to bias resistor through centre-tapped secondary L6 of OP1 so that part of the output load is driven by the cathodes. Secondary L5 is tapped for output impedances of 7.5 and 15 ohms.

Output voltage appearing across secondary L5 is fed by R27 to R26 in common cathode circuit of V3, V4 as negative feedback.

HT is provided by a directly heated full-wave rectifier V7. Its anode voltages are obtained from HT secondary L8 of mains input transformer MT1 and heater current from secondary L7. HT for anodes of output valves is obtained direct from reservoir smoothing capacitor C24. HT for V3, V4, however, is choke-capacity smoothed by L3, C23. Control unit HT is further resistance-capacity smoothed by R12, C5, R6, C2.

Reservoir smoothing capacitor C24 should be capable of handling 175mA ripple current.

Heaters of V1 to V6 are connected in parallel and obtain their current from LT secondary L9 of MT1 the centre tap of which is earthed to chassis.

HT and heater supplies are fed to an outlet socket to provide power for a radio tuner unit. HT current must not exceed 25 mA and heater current 2 A.

Primary L10 of MT1 is tapped for inputs of 200-215, 220-230, 240-250V 40-80c/s. S4, which is located on main amplifier chassis, is the ON/OFF switch. Mains tapping link-plug incorporates a repairable fuse holder wired for 1 A.

COSSOR

499UB

from page 22.

In this layout diagram the details of the dial drive are inset towards the base

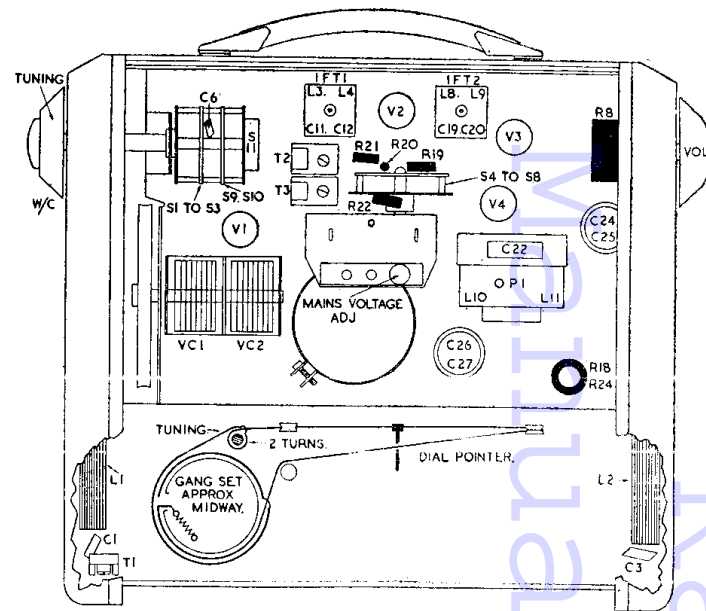

control R8 to pentode amplifier section of V3. Automatic bias for grid is developed on C15 with R10 as leak. Screen voltage is obtained from R12 decoupled by C18. Suppressor is internally strapped to negative side of filament. Anode load resistor is R11.

Output Stage.—C21 feeds signal at anode V3 to pentode output amplifier V4. Grid is biased negatively by returning grid resistor R13 to chassis through R14 in the negative HT lead. Screen voltage is obtained direct from HT line decoupling being given by C26.

Primary L10 of output matching transformer OP1 is in the anode circuit. Fixed tone correction is given by C22. Secondary L11 feeds signal to a 6 $\frac{1}{2}$ in. PM speaker L12.

HT of 90V is provided by two 45V Ever Ready Batrymax type B104 units connected in series or, alternatively, from the mains. S4, which is ganged with S5 to S8 and automatically operated by insertion of mains plug in socket at rear of cabinet, switches the HT line of receiver from battery to mains.

On mains operation HT is obtained by feeding input mains through tapped dropper resistor formed by R23, R24 to half-wave metal rectifier W1. Output of rectifier is smoothed by R17, C27, C26 and applied to HT line of receiver. C28 is mains input filter capacitor.

Reservoir smoothing capacitor C27 is rated to handle 175mA ripple current.

Mains input is switched by S11 which is ganged to wavechange switching.

On battery operation C26 serves to decouple the HT battery. S9 which is ganged to wavechange switch is HT battery ON/OFF switch.

LT of 7.5V for the series-connected filaments of V1 to V4 is provided by an Ever Ready All-dry 31 battery or, if the receiver is operated from the

mains, from HT reservoir smoothing capacitor C27 through potential divider formed by R18 to R22.

R16, R9, R15 are filament current bypass resistors and C14, C5, C24, C25, C29 filament smoothing and decoupling capacitors.

Filament line of receiver is switched from battery to mains LT by S5 to S8 which are automatically operated when mains plug is inserted in socket at rear of cabinet. R18 is main filament dropper resistor and R19 to R22 serve as additional shunt resistors and also protect the low voltage electrolytic capacitors C24, C25 from breakdown if filament line becomes open circuit.

S10 which is ganged to S9 and wavechange switch is LT battery ON/OFF switch.

Removal of chassis.—Remove rear metal cover of case by loosening the two knurled nuts on underside of cabinet. Remove front metal cover by undoing the two 6BA bolts at lower edge and also the self-tapping screw midway up each side—these latter screws are accessible from rear of chassis. Undo LS clamping ring bolt and withdraw LS from front of case. All components, etc. are now accessible without the need for further dismantling.

TRIMMING INSTRUCTIONS

Apply signal as stated below	Tune receiver to	Trim in order stated for maximum output
(1) 470kc/s to g3 of V1 via .01mF	—	Cores L9, L8, L4 and L3
(2) 1.45mc/s to frame AE via coupling loop	206.5 metres	T2, T1
(3) 160kc/s as above	1875 metres	T3