

# Wireless Retailer & BROADCASTER SERVICE ENGINEER

## LISSEN 8130 THREE-BAND A.C.-D.C. THREE

**CIRCUIT.**—A three-valve receiver for operation on either A.C. or D.C. mains. Three wavelengths are covered: short waves from 18.5 to 54 metres, and the usual medium and long wavelengths.

The input to V1, an H.F. pentode, is through a series condenser, C5, and a top-capacity and inductively coupled tuned coil. Volume is controlled in this valve by means of a potentiometer varying the amount of bias applied to the cathode.

Coupling between V1 and V2, which is a triode, is through a tuned circuit, reaction being employed in the orthodox manner. A separate reaction coil is used on short waves.

The L.F. output of V2 is then passed via a parallel-fed L.F. transformer to the output pentode V3.

Tone is varied by C19, which may be put in or out of circuit by means of a flying lead located at the back of the chassis.

Mains equipment consists of strapped rectifier, electrolytic condensers and the speaker field.

**Removing Chassis.**—To obtain access to the underside of the chassis, turn the cabinet on one side and remove the false bottom, which is secured by wood screws.

To remove the chassis, first pull off the control knobs (spring clips), pull out the speech coil connecting plugs, disconnect field supply leads from terminal strip on back of speaker and free them from the cleats; then unscrew the mains switch and remove the side of the cabinet, and remove four bolts from underneath.

The chassis will then be quite free and may be completely removed from the cabinet.

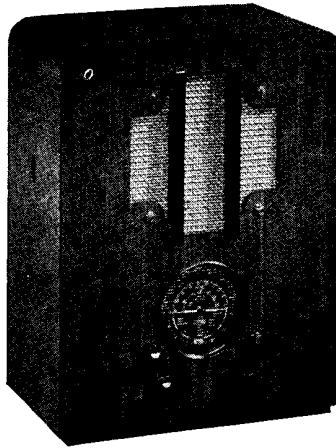

The Lissen 8130 is a straight three for A.C.-D.C. mains, and covers short, medium and long wave-bands.

**Special Notes.**—The dial lamps are rated at 3.5 volts .3 amp. To remove them, first take out the valves, thus exposing two knurled headed units securing the holders to the dial assembly. When these are unscrewed the holders may be removed far enough for easy replacement of the lamps.

The external speaker is connected on the secondary of the output transformer and should have a speech-coil resistance of about 2 ohms.

### ALIGNMENT NOTES

**Calibration.**—With the condenser vanes fully meshed, the pointers should coincide with the horizontal lines dividing the scale. If this is not so, they may be adjusted by slackening the centre fixing screw.

**Medium Waves.**—Connect a modulated oscillator tuned to 202 metres to the aerial and earth terminals and an output meter across the speaker terminals. Tune in the signal and with reaction at minimum adjust T1 and T2 for maximum reading on output meter.

**Short Waves.**—Inject and tune in a signal of 18.4 metres, adjusting the reaction control to just before the point where the set oscillates; then, while rocking the gang condenser, adjust T3 for maximum output. Readjust the reaction control if necessary.

### VALVE READINGS

No signal and no reaction. 200 volts A.C. mains.

V.	Type.	Electrode.	Volts.	M/a.
1	(All Ever Ready) C50N (7)	... anode ...	140	7.5
		... screen ...	180	3.1
2	C30B (7)	... anode ...	—	—
		... screen ...	38	2.3
3	C70D (7)	... anode ...	155	37
		... screen ...	184	8.5
4	C10B (5)	... cathode	216	—

### QUICK TESTS

Quick tests are available on this receiver on the terminal strip on the right hand side of the speaker chassis. Volts measured between this and the chassis should be:—

- (1) 216 volts unsmoothed H.T.
- (2) 184 volts smoothed H.T.

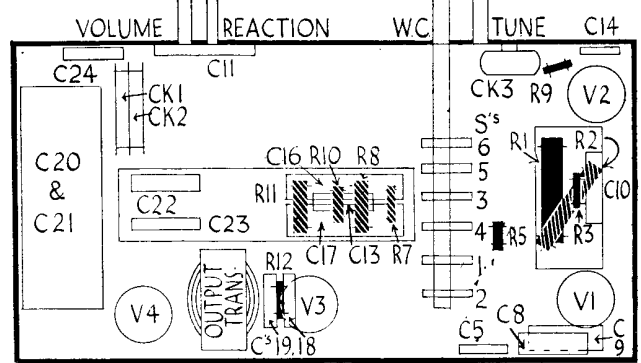
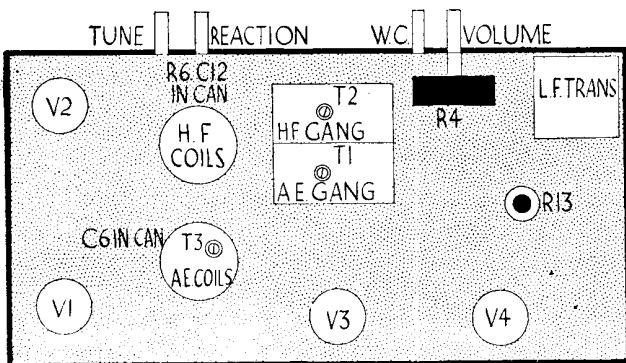

Chassis layouts of the Lissen 8130. The "tinted" drawing on the left shows the top, while on the right is the underside view. All resistances, including variables, are shown in solid black for easy reference.

For more information remember  
[www.savoy-hill.co.uk](http://www.savoy-hill.co.uk)

# LISSEN 8130 THREE-BAND A.C.-D.C. THREE

## Circuits and Component Values

### INSTRUMENTS FOR REVIEW

REQUESTS for reviews of sets not hitherto dealt with are welcomed.

Efforts are made to comply with all such requests, provided they are of sufficient general interest, and if a receiver can be obtained by our engineers.

CONDENSERS		
C.	Purpose.	Mfd.
5	Aerial isolating ...	.0002
6	Aerial coupling ...	.00001
8	V1 H.T. decoupling ...	.1
9	V1 cathode bias shunt ...	.1
10	V1 anode decoupling... ..	.1
11	Reaction ...	—
12	V2 grid... ..	.00005
13	L.F. coupling ...	.1
14	H.F. by-pass ...	.0001
15	H.F. by-pass ...	.0003
16	V2 anode decoupling... ..	2
17	V3 cathode bias shunt ...	50
18	Pentode compensating ...	.01
19	Tone ...	.01
20	H.T. smoothing ...	10
21	H.T. smoothing ...	8
22	Mains filter ...	.1
23	Mains filter ...	.1
24	Mains filter ...	.1

RESISTANCES		
R.	Purpose.	Ohms.
1	V1 screen decoupling potentiometer ...	31,000
2	V1 screen decoupling potentiometer ...	31,000
3	V1 cathode bias ...	200
4	Volume control ...	10,000
5	V1 anode decoupling... ..	5,000
6	V2 grid leak ...	510,000
7	V2 anode decoupling... ..	11,000
8	V2 anode feed... ..	50,000
9	H.F. stopper ...	2,000
10	V3 grid stopper ...	26,000
11	V3 cathode bias ...	200
12	Tone compensating ...	11,000
13	Voltage dropper ...	796

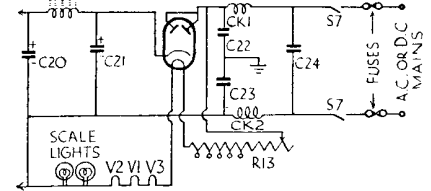

Mains equipment of the Lissen 8130. The arrows on the left indicate connections to the receiver portion below.

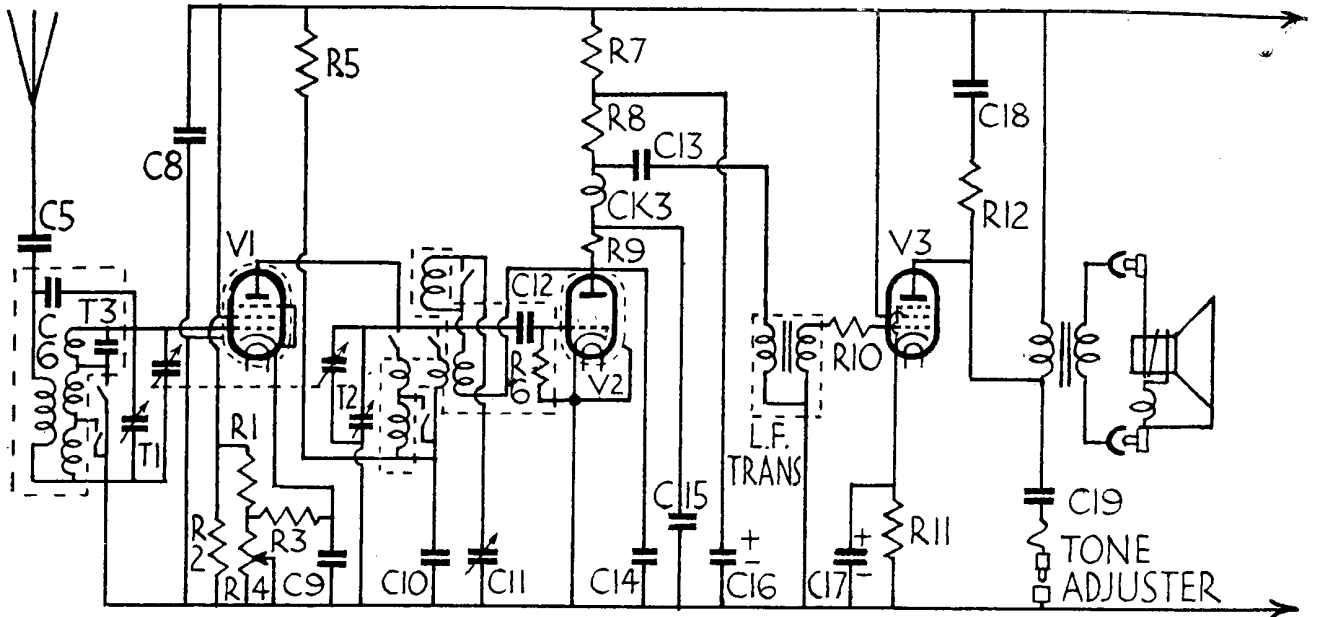

The circuit of the Lissen 8130 A.C.-D.C. all-wave three. This portion is the signal-handling end; the arrows on H.T. and earth lines on the right show the connections to the mains equipment, reproduced separately above.

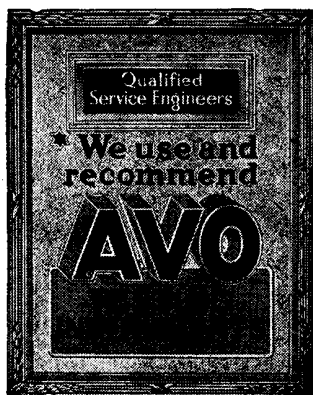

## The Sign of GOOD SERVICE

BRINGS GOODWILL AND TRADE

You can be certain of securing good business if you use "Avo" Testing Instruments. Their precision and dependability provide you with servicing qualifications which the public widely appreciate, and which are clearly recognisable by your display of the gold-embossed "Avo" Service Sign. The public is being taught by persistent press advertising to recognise the "Avo" Service Sign as the Hall Mark of the qualified dealer. It will establish customer-confidence in your reliability. The "Avo" Service Sign will be supplied free on request to responsible dealers and service engineers.

The AUTOMATIC COIL WINDER & ELECTRICAL EQUIPMENT CO., LTD., Winder House, Douglas Street, London, S.W.1.  
Phone: Victoria 3404/7.

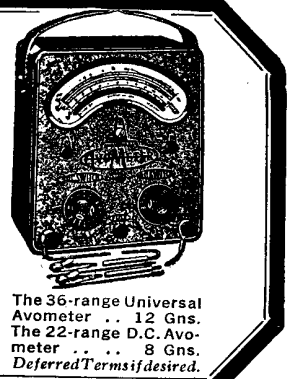

The 36-range Universal Avometer . . . 12 Gns.  
The 22-range D.C. Avometer . . . 8 Gns.  
Deferred Terms if desired.